

36 Riversea Plantation
Kelli plan

992 Ashburton Rd SE

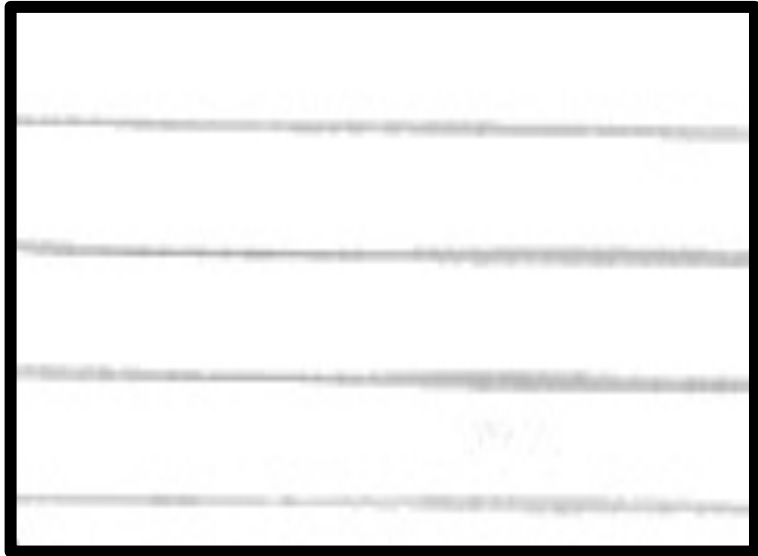

House and Gables Exterior-White
6512-75380
SW-Superpaint Extra White

Windows
Soffit-White

Drip edge-Black
Gutters black



Tamko Heritage
Virginia Slate shingles



Shutters
Black



White
Ranch



Door style
Color Black
RAIN glass

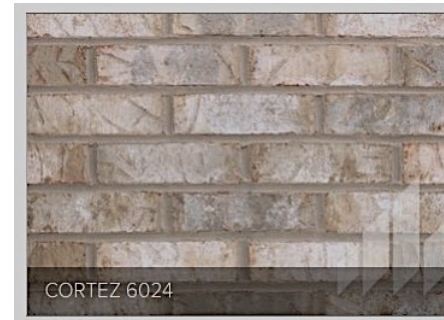

Foundation sides and back
General Shale Brick
Cortez OS with white mortar



KINGSFORD GREY LEDGESTONE
Stone

36 Riversea Plantation
Kelli plan

992 Ashburton Rd SE

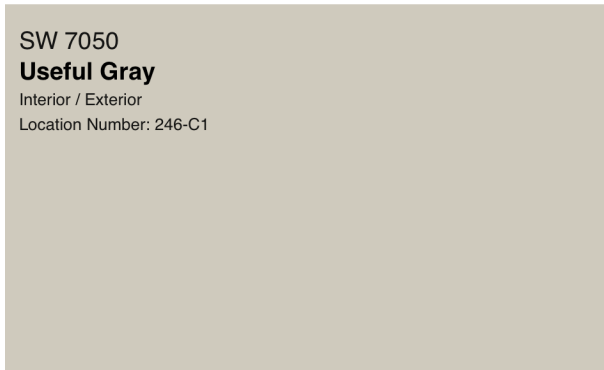

Interior Paint flat
Useful grey

36 Riversea Plantation
Kelli plan

992 Ashburton Rd SE

Counter tops

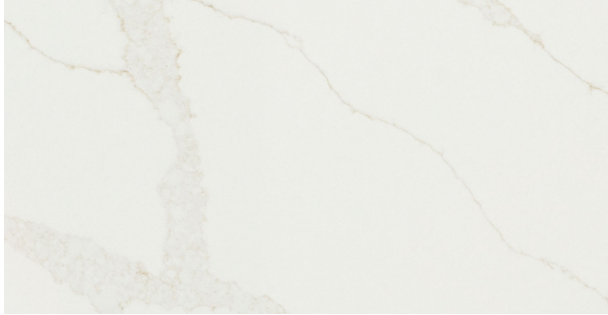

Kitchen and Laundry room
Calacatta Elysio

Kitchen single hole faucet
Hole for soap dispenser
Hole for pneumatic switch

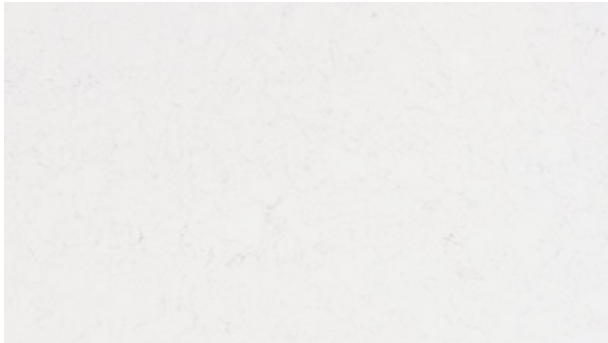

Master and hall baths
Cloud Quartz-eased

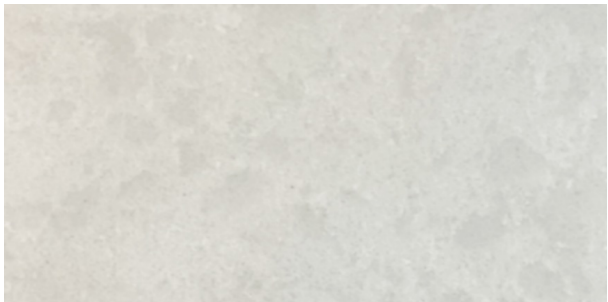

Bonus bath
Elegance quartz-eased edge

Sinks

White blanco sink in kitchen single bowl
Rectangle bowls in all baths
Single bowl SS in laundry

Bath faucets

Wide spread faucets in all 3 baths

36 Riversea Plantation
Kelli plan

992 Ashburton Rd SE



All baths
Master, hall, powder, bonus
Delta Woodhurst. 3532LF-SSMPU

Faucets



Peerless P7919
Kitchen SS

Kitchen-with soap dispenser
and pneumatic switch



Delta Woodhurst Stainless
58474-25
Master, hall and bonus baths

36 Riversea Plantation
Kelli plan

992 Ashburton Rd SE



Pendants (2)



Bonus room



Master bath



Guest bath-hall



Powder room



Bedrooms 2 & 3



Great room, master bedroom
sunroom



Back porch

36 Riversea Plantation
Kelli plan

992 Ashburton Rd SE



All rooms
Homecrest-Sedona
Mystic Full overlay
throughout



Bathrooms- Doors and drawers



Kitchen and laundry -doors and drawers

36 Riversea Plantation
Kelli plan

992 Ashburton Rd SE



Whirlpool
WDT750SAKZ



Whirlpool
WWW57UC6FS



Whirlpool
WMCS7024PZ

COOKTOP CUTOUT

| | |
|------------------|-----------|
| Cutout Depth | 20 in |
| Cutout Depth Max | 20 in |
| Cutout Depth Min | 19 in |
| Cutout Width | 35-1/4 in |
| Cutout Width Max | 35-1/4 in |

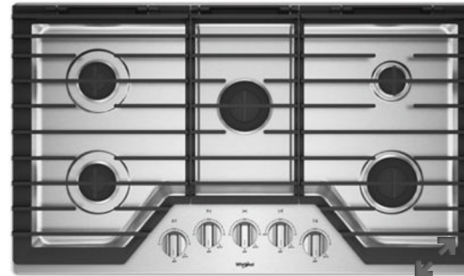

Whirlpool
WCGK5036PS



Whirlpool
WOES5030LZ

Required Cutout Dimensions-2.2 cuft.

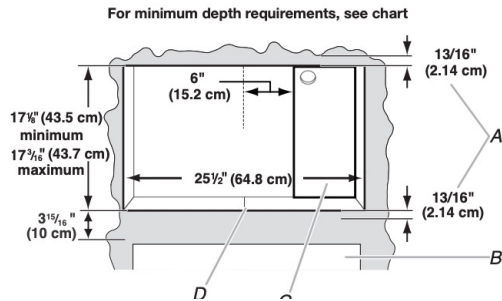

Microwave cutout

Required Cutout Dimensions-2.2 cuft.

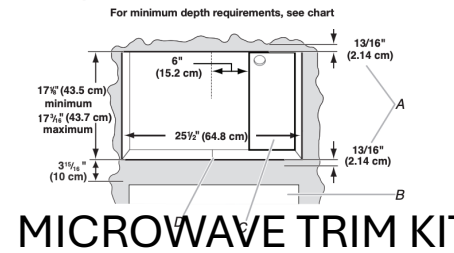

MICROWAVE TRIM KIT

Wall oven Install info

36 Riversea Plantation
Kelli plan

992 Ashburton Rd SE



LVP
Metrofloor Inception
FA 204-Forest Oak
Foyer-Study-Great-room-kitchen-pantry
Dining room-sunroom
Master bedroom and closets
Powder room-laundry room



Kitchen Backsplash
Daltile-Stagecraft 3 x12
Artic White
Mapei Avalanche grout



Michealangelo Light
Hall bath surround and floor 12 X 24
Bonus bath floor
Laticrete Frosty with Frosty slueter



Fireplace surround
American Olean
Conrad Brick-Horizontal
Oyster grey grout

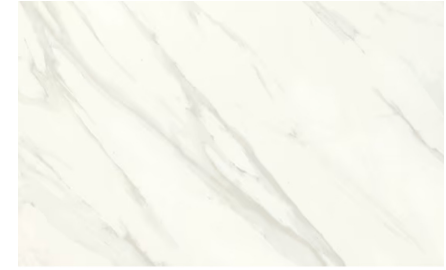

Daltile-Florentine
Master bath shower-bathroom floor
Mapei Frost grout



Carpet-Mohawk Detailed Memories 1
color Sandy Shores 727
bedroom 2 and 3, bonus room and stairs