

64 Riversea
953 Ashburton Way

Kelli Plan

SW 7016
Mindful Gray
Interior / Exterior
Location Number: 244-C2

House Exterior to include gables
And dormers

SW 7006
Extra White
Interior / Exterior
Location Number: 257-C1

Exterior trim color
SW 7006 Extra White

White
Windows
soffit-drip edge
Gutters

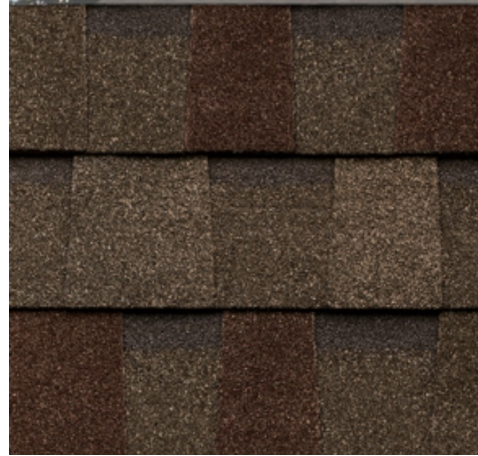

Tamko Classic
Heritage Weathered
shingles

Stockbridge
Garage door inserts

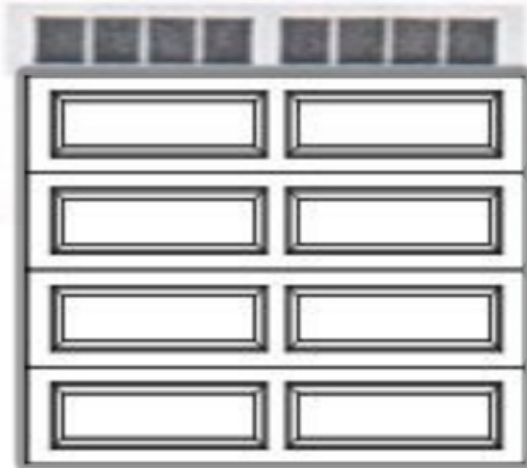

Garage door- ranch style



Shutters-raised
Musket Brown



Exterior door style
With rain glass

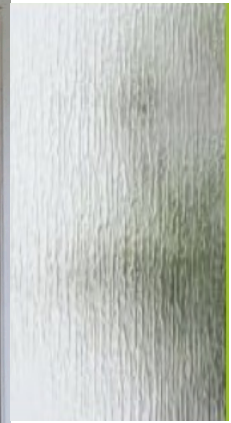

Front door color
SW Black Fox
SW 7021

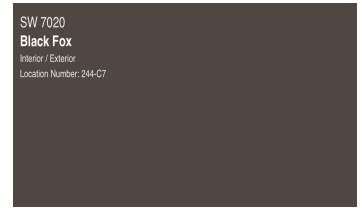

SW 7020
Black Fox
Interior / Exterior
Location Number: 244-C7

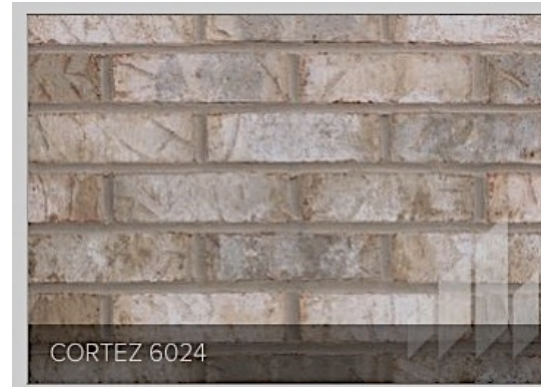

Foundation sides and back
General Shale Brick
Cortez OS with grey mortar



Front foundation Stone
Pennsylvania Ledge Stone
Sill-Stonecraft Grey

64 Riversea
953 Ashburton Way
Kelli plan



Kitchen- Rico

Kitchen sink- Blanco White single bowl
32"

Wide spread faucets in baths

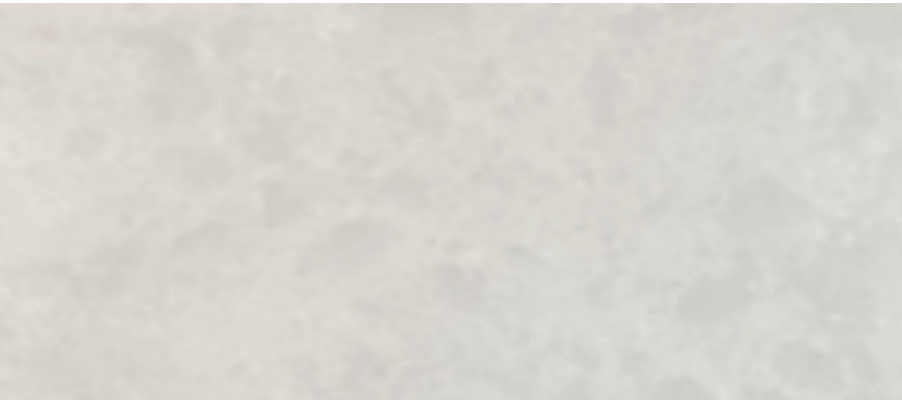

Master bath and hall bath

Elegance

rectangle sinks

Wide spread faucets

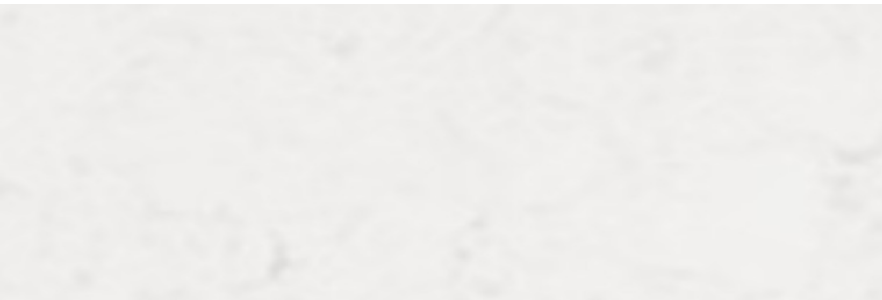

Bonus bath- Carrara cloud

64 Riversea
953 Ashburton Way
Kelli plan



Marsh-Atlanta White
ALL rooms



Laundry room Formica-Calcutta Marble4925-7
Ultra-no drip edge



All cabinet doors and drawers

64 Riversea
953 Ashburton DR
Kelli



Great room, master bedroom, sunroom



Master bath



Back porch



Pendants



Guest Bath and bonus bath



Bonus room



Bedrooms #2 & #3/study

64 Riversea
953 Ashburton DR
Kelli

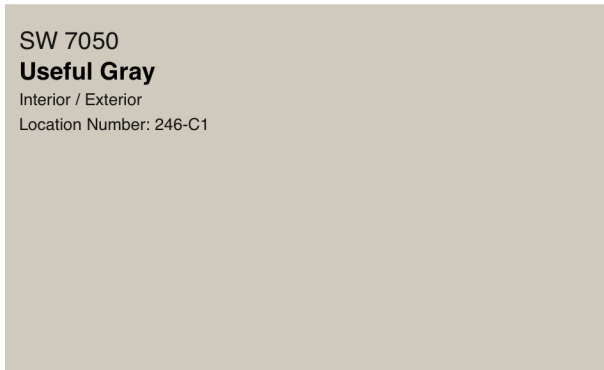

Interior Paint flat
Useful grey

64 Riversea
953 Ashburton DR
Kelli

Faucets



Delta 3532
Woodhurst-All baths
2-8" spread-Chrome



Peerless P7919
Kitchen SS
Delta Leland style faucet or similar
Kitchen-with soap dispenser
and pneumatic switch



Tub/Shower trim
Chrome
Delta 58474

64 Riversea
953 Ashburton DR
Kelli



LVP
Metrofloor Inception
FA 204-Forest Oak
Foyer, dining room, family room
Kitchen, sunroom, Master bedroom and closet
laundry, Halls to bedrooms, study



Carpet-Mohawk Detailed Moments 1
Harmony- bedroom 2, bonus room and stairs



Hall bath tub surround and bonus shower
4x14 horizontal staggered 1/2
12x24 on floors
Frost grout



Master bath
Walls and bath floor 12x24
Floridatile Alustra-Majestic White Lasa matte
Hex on shower floor
Frost grout

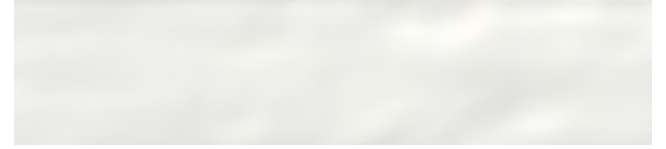

Backsplash-Daltile Stagecoach
Artic White 3x12 glossy
Avalanche grout

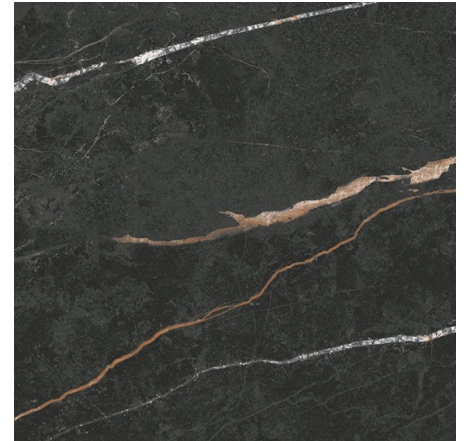

Fireplace surround
Daltile Infinite black

64 Riversea
953 Ashburton Way



Whirlpool
WDT750SAKZ



Whirlpool
WVV57UC6FS



Whirlpool
WMCS7024PZ

COOKTOP CUTOUT

Cutout Depth	20 in
Cutout Depth Max	20 in
Cutout Depth Min	19 in
Cutout Width	35-1/4 in
Cutout Width Max	35-1/4 in

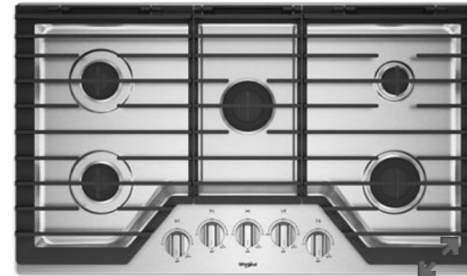

Whirlpool
WCGK5036PS



Whirlpool
WOES5030LZ

Required Cutout Dimensions-2.2 cuft.

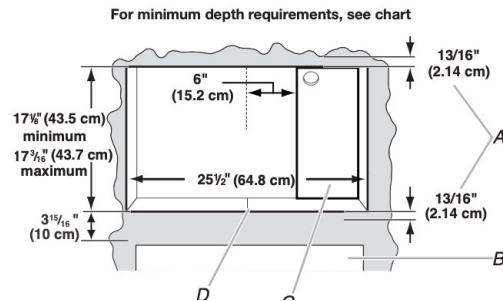

Microwave cutout

Required Cutout Dimensions-2.2 cuft.

For minimum depth requirements, see chart

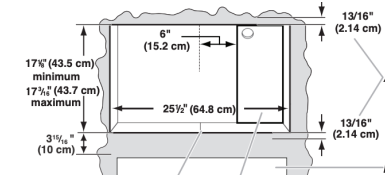

MICROWAVE TRIM KIT

Wall oven Install info

<https://www.whirlpool.com/content/dam/global/documents/202204/owners-manual-w11340821-revC.pdf>