

**Lot 357 Riversea
660 Breezewood DR
Krystal's Retreat Plan**

SW 6199
Rare Gray
Interior / Exterior
Location Number: 216-C3

**House gable and
dormer(s) –green NOT
gray-can see at 774
Cedarhurst**



Shingles-Tamko Classic
Heritage Weathered wood



Front door style
RAIN glass
Door color Sherwin Williams-
SW 7642
Pavestone



Stockbridge

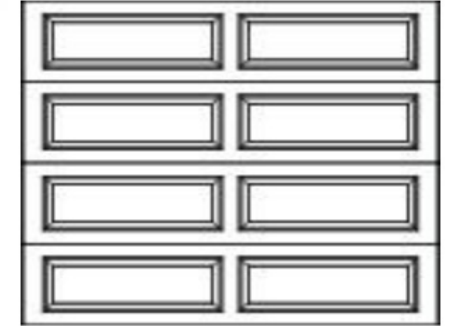

white
Ranch

SW 7568
Neutral Ground
Interior / Exterior
Location Number: 261-C5

Exterior Trim



Foundation sides and back
General Shale Brick
Cortez OS with grey mortar

Soffit-drip edge and gutters-CAMEO

Windows-white



Shutters raised panel
Tuxedo Grey

**Lot 357 Riversea
660 Breezewood DR
Krystal's Retreat Plan**



Foyer



Dining room



Screened Porch



Bonus room



Kitchen Nook



Pendants (3)



Great room, Master bedroom
Sunroom



Guest Bath



Bedroom 2 & 3



Master bath
And Powder room

**Lot 357 Riversea
660 Breezewood DR
Krystal's Retreat Plan**



LVP Cali- Aged Hickory
Foyer-Living Room-Dining room-
nook
sunroom-Master bedroom and
closet
Powder room-laundry room

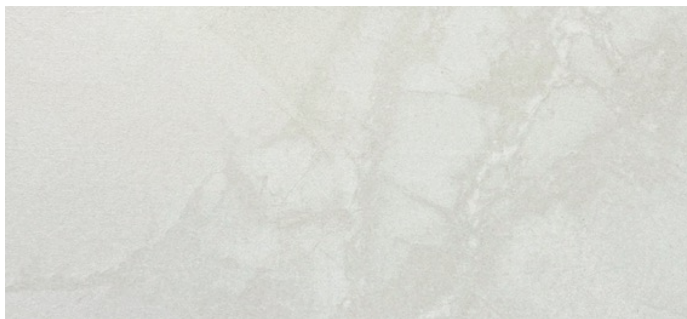

Master bath shower walls and floor
Florida tile Micheangelo Light
Horizontal
Herringbone on shower floor
Laticrete grout-Frosty



Kitchen Backsplash
Daltile-Stagecraft 3 x12
Artic White
Mapei Avalanche grout



Fireplace surround
American Olean
Conrad Brick-Horizontal
Oyster grey grout



Carpet-Mohawk Detailed Memories 1
color Linen Taupe749
bedroom 2 and 3, bonus room and stairs



Hall bath floor 12 X 24
Florida Tile Brillance white

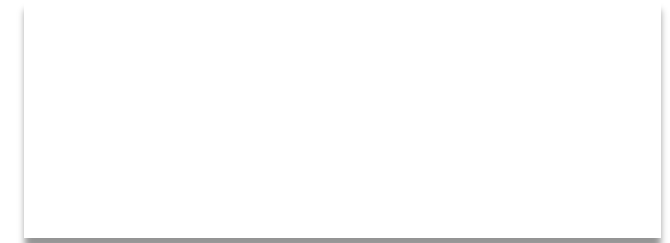

Hall tub surround
Daltile color wheel
Arctic White Gloss 4" X 12"
Bright White grout

**Lot 357 Riversea
660 Breezewood DR
Krystal's Retreat Plan**

Counter tops

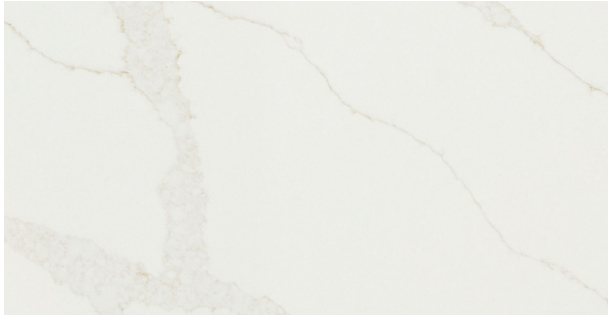

Kitchen and Laundry room
Calacatta Elysio

Kitchen single hole faucet
Hole for soap dispenser
Hole for pneumatic switch

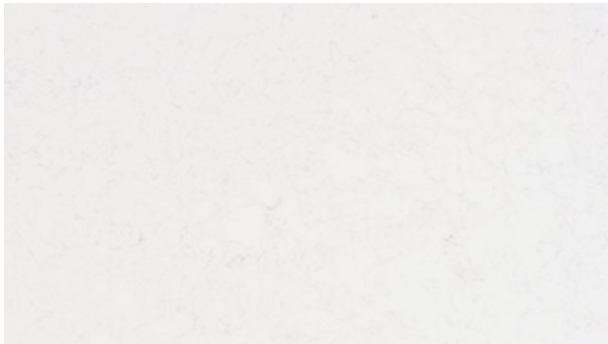

Master and hall baths
Cloud Quartz-eased

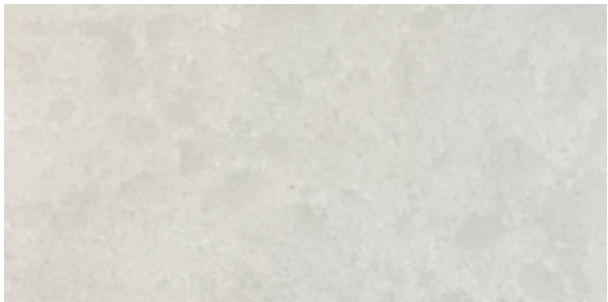

Bonus bath and powder room
Elegance quartz-eased edge

Sinks

White blanco sink in kitchen single bowl
Rectangle bowls in all baths
Single bowl SS in laundry

Bath faucets

Wide spread faucets in all 4 baths

Lot 357 Riversea
660 Breezewood DR
Krystal's Retreat Plan



Whirlpool
WDT750SAKZ



Whirlpool
WWW57UC6FS



Whirlpool
WMCS7024PZ

COOKTOP CUTOUT

Dimensions

Product Dimensions (H x W x D)	4-1/8" x 36" x 21"
Cutout Dimensions (W x D)	33-7/8" x 19"

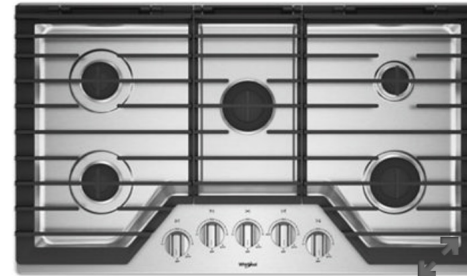

Whirlpool
WCGK5036PS



Whirlpool
WOES5030LZ

Required Cutout Dimensions-2.2 cuft.

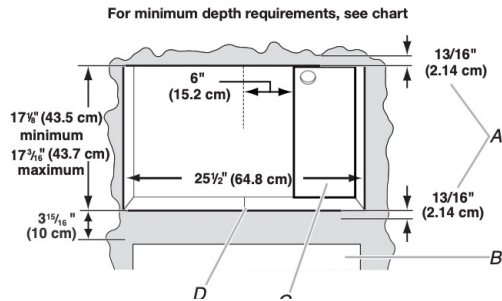

Microwave cutout

Required Cutout Dimensions-2.2 cuft.

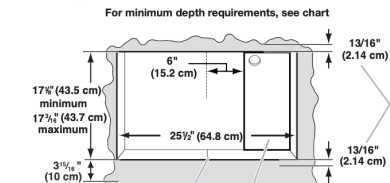

MICROWAVE TRIM KIT

Wall oven Install info

**Lot 357 Riversea
660 Breezewood DR
Krystal's Retreat Plan**

Faucets



All baths
Master, hall, powder, bonus
Delta Woodhurst. 3532LF-SSMPU



Peerless P7919
Kitchen SS

Kitchen-with soap dispenser
and pneumatic switch



Delta Woodhurst Stainless
58474-25
Master, hall and bonus baths

**Lot 357 Riversea
660 Breezewood DR
Krystal's Retreat Plan**



Kitchen ,master bath,
powder room and hall bath
Homecrest-Sedona 5 pc
Mystic Full overlay
throughout



Laundry room and bonus baths
Sedona 5 pc-Churro



Bathrooms- Doors
Elements-Z500-128SN



bath drawers
Elementms Madison 3910SN



Kitchen and laundry -doors and drawers
Elements Hadley-449-160SN